

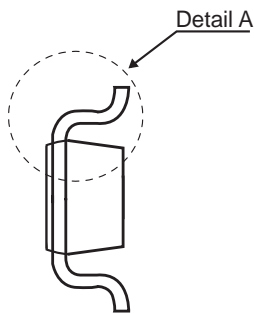

Package Outline Dimensions

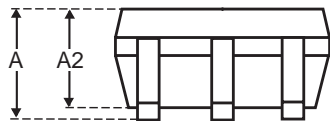

SYMBOLS	MILLIMETERS		
	Min.	Nom.	Max.
A	0.80	-	1.10
A2	0.80	0.90	1.00
b	0.15	0.20	0.30
D	1.80	2.00	2.20
E	2.15	2.30	2.45
E1	1.15	1.25	1.35
e	-	0.65	-
e1	1.20	1.30	1.40
L	0.30	-	0.45
L2	0.10	0.15	0.25
R	0.10	-	-
	0°		10°

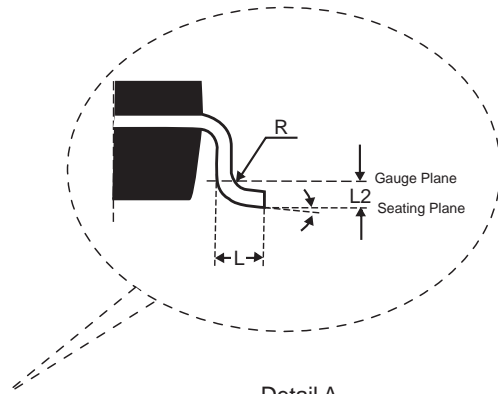
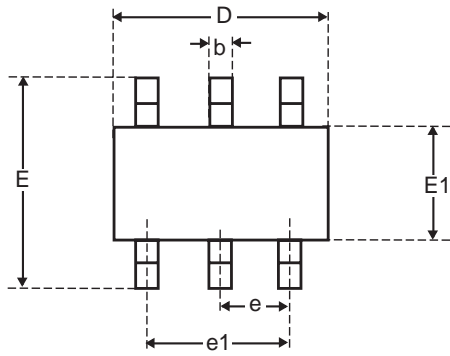

Carrier Tape & Reel Dimensions

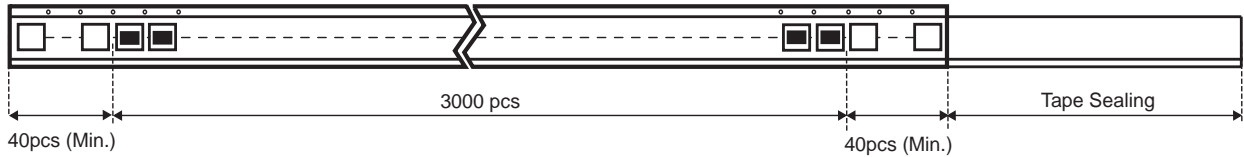
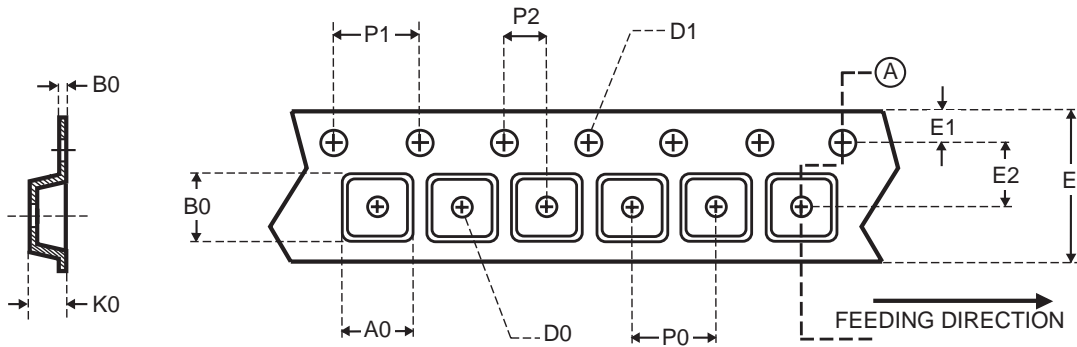

Package	A0	B0	K0	D0	D1	E	E1	E2	P0	P1	P2	
SOT-363	3.20 ± 0.10	3.00 ± 0.10	1.33 ± 0.10	1.00 + 0.25	1.50 + 0.10	8.00 + 0.30 - 0.10	1.75 ± 0.10	3.50 ± 0.05	4.00 ± 0.10	4.00 ± 0.10	2.00 ± 0.05	0.20 ± 0.02

UNIT : mm

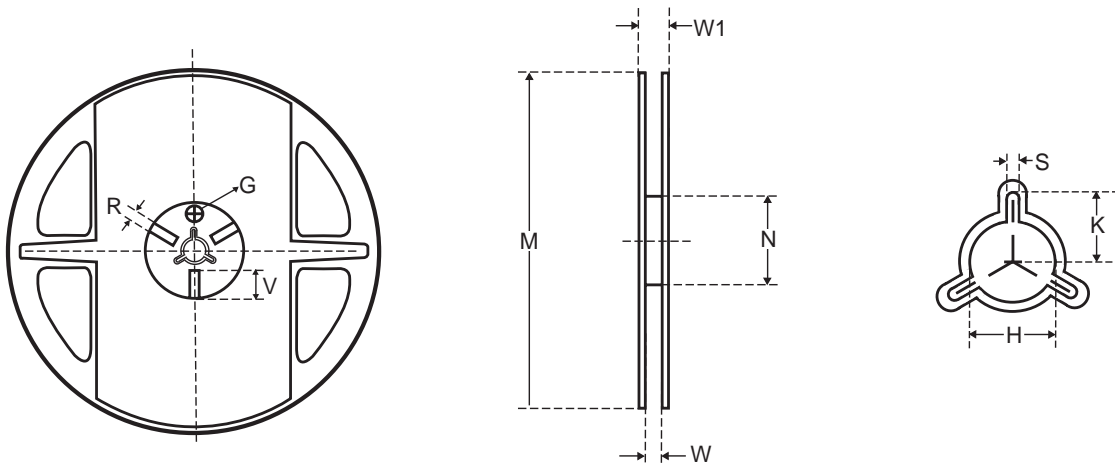

Tape size	Reel Size	M	N	W	W1	H	K	S	G	R	V
8mm	178	178 ± 1	60 ± 1	9.0 ± 0.5	12.0 ± 0.5	13.5 ± 0.5	10.5	2.0 ± 0.5	10.0	5.0	18.0

UNIT : mm